

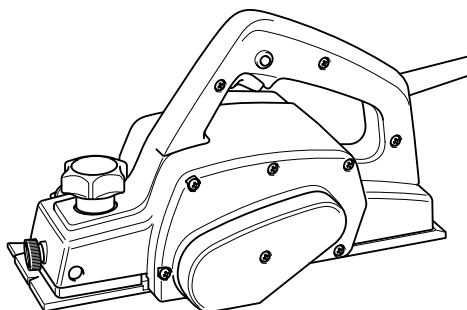

INSTRUCTION MANUAL

# Power Planer

1923H



010674

 DOUBLE INSULATION

**IMPORTANT:** Read Before Using.

## ENGLISH (Original instructions)

### SPECIFICATIONS

Model	1923H
Planing width	82 mm
Planing depth	3.5 mm
Shiplapping depth	23 mm
No load speed (min <sup>-1</sup> )	16,000
Overall length	293 mm
Net weight	3.5 kg
Safety class	□/II

- Due to our continuing programme of research and development, the specifications herein are subject to change without notice.
- Specifications may differ from country to country.
- Weight according to EPTA-Procedure 01/2003

END201-5

### Symbols

The following show the symbols used for the equipment. Be sure that you understand their meaning before use.



- Read instruction manual.



- DOUBLE INSULATION



- Only for EU countries

Do not dispose of electric equipment together with household waste material! In observance of European Directive 2002/96/EC on waste electric and electronic equipment and its implementation in accordance with national law, electric equipment that have reached the end of their life must be collected separately and returned to an environmentally compatible recycling facility.

ENE001-1

### Intended use

The tool is intended for planing wood.

ENF002-2

### Power supply

The tool should be connected only to a power supply of the same voltage as indicated on the nameplate, and can only be operated on single-phase AC supply. They are double-insulated and can, therefore, also be used from sockets without earth wire.

GEA005-3

## General Power Tool Safety

### Warnings

 **WARNING** Read all safety warnings and all instructions. Failure to follow the warnings and instructions may result in electric shock, fire and/or serious injury.

## Save all warnings and instructions for future reference.

The term "power tool" in the warnings refers to your mains-operated (corded) power tool or battery-operated (cordless) power tool.

### Work area safety

1. **Keep work area clean and well lit.** Cluttered or dark areas invite accidents.
2. **Do not operate power tools in explosive atmospheres, such as in the presence of flammable liquids, gases or dust.** Power tools create sparks which may ignite the dust or fumes.
3. **Keep children and bystanders away while operating a power tool.** Distractions can cause you to lose control.

### Electrical safety

4. **Power tool plugs must match the outlet. Never modify the plug in any way. Do not use any adapter plugs with earthed (grounded) power tools.** Unmodified plugs and matching outlets will reduce risk of electric shock.
5. **Avoid body contact with earthed or grounded surfaces such as pipes, radiators, ranges and refrigerators.** There is an increased risk of electric shock if your body is earthed or grounded.
6. **Do not expose power tools to rain or wet conditions.** Water entering a power tool will increase the risk of electric shock.
7. **Do not abuse the cord. Never use the cord for carrying, pulling or unplugging the power tool. Keep cord away from heat, oil, sharp edges or moving parts.** Damaged or entangled cords increase the risk of electric shock.
8. **When operating a power tool outdoors, use an extension cord suitable for outdoor use.** Use of a cord suitable for outdoor use reduces the risk of electric shock.

9. **If operating a power tool in a damp location is unavoidable, use a residual current device (RCD) protected supply.** Use of an RCD reduces the risk of electric shock.
10. **Use of power supply via a RCD with a rated residual current of 30mA or less is always recommended.**

#### Personal safety

11. **Stay alert, watch what you are doing and use common sense when operating a power tool. Do not use a power tool while you are tired or under the influence of drugs, alcohol or medication.** A moment of inattention while operating power tools may result in serious personal injury.
12. **Use personal protective equipment. Always wear eye protection.** Protective equipment such as dust mask, non-skid safety shoes, hard hat, or hearing protection used for appropriate conditions will reduce personal injuries.
13. **Prevent unintentional starting. Ensure the switch is in the off-position before connecting to power source and/or battery pack, picking up or carrying the tool.** Carrying power tools with your finger on the switch or energising power tools that have the switch on invites accidents.
14. **Remove any adjusting key or wrench before turning the power tool on.** A wrench or a key left attached to a rotating part of the power tool may result in personal injury.
15. **Do not overreach. Keep proper footing and balance at all times.** This enables better control of the power tool in unexpected situations.
16. **Dress properly. Do not wear loose clothing or jewellery. Keep your hair, clothing, and gloves away from moving parts.** Loose clothes, jewellery or long hair can be caught in moving parts.
17. **If devices are provided for the connection of dust extraction and collection facilities, ensure these are connected and properly used.** Use of dust collection can reduce dust-related hazards.

#### Power tool use and care

18. **Do not force the power tool. Use the correct power tool for your application.** The correct power tool will do the job better and safer at the rate for which it was designed.
19. **Do not use the power tool if the switch does not turn it on and off.** Any power tool that cannot be controlled with the switch is dangerous and must be repaired.
20. **Disconnect the plug from the power source and/or the battery pack from the power tool before making any adjustments, changing**

**accessories, or storing power tools.** Such preventive safety measures reduce the risk of starting the power tool accidentally.

21. **Store idle power tools out of the reach of children and do not allow persons unfamiliar with the power tool or these instructions to operate the power tool.** Power tools are dangerous in the hands of untrained users.
22. **Maintain power tools. Check for misalignment or binding of moving parts, breakage of parts and any other condition that may affect the power tool's operation. If damaged, have the power tool repaired before use.** Many accidents are caused by poorly maintained power tools.
23. **Keep cutting tools sharp and clean.** Properly maintained cutting tools with sharp cutting edges are less likely to bind and are easier to control.
24. **Use the power tool, accessories and tool bits etc. in accordance with these instructions, taking into account the working conditions and the work to be performed.** Use of the power tool for operations different from those intended could result in a hazardous situation.

#### Service

25. **Have your power tool serviced by a qualified repair person using only identical replacement parts.** This will ensure that the safety of the power tool is maintained.
26. **Follow instruction for lubricating and changing accessories.**
27. **Keep handles dry, clean and free from oil and grease.**

GEB010-4

## PLANER SAFETY WARNINGS

1. **Wait for the cutter to stop before setting the tool down.** An exposed cutter may engage the surface leading to possible loss of control and serious injury.
2. **Hold the power tool by insulated gripping surfaces only, because the cutter may contact its own cord.** Cutting a "live" wire may make exposed metal parts of the power tool "live" and could give the operator an electric shock.
3. **Use clamps or another practical way to secure and support the workpiece to a stable platform.** Holding the work by hand or against your body leaves it unstable and may lead to loss of control.
4. **Rags, cloth, cord, string and the like should never be left around the work area.**
5. **Avoid cutting nails. Inspect for and remove all nails from the workpiece before operation.**
6. **Use only sharp blades. Handle the blades very carefully.**

7. Be sure the blade installation bolts are securely tightened before operation.
8. Hold the tool firmly with both hands.
9. Keep hands away from rotating parts.
10. Before using the tool on an actual workpiece, let it run for a while. Watch for vibration or wobbling that could indicate poor installation or a poorly balanced blade.
11. Make sure the blade is not contacting the workpiece before the switch is turned on.
12. Wait until the blade attains full speed before cutting.
13. Always switch off and wait for the blades to come to a complete stop before any adjusting.
14. Never stick your finger into the chip chute. Chute may jam when cutting damp wood. Clean out chips with a stick.
15. Do not leave the tool running. Operate the tool only when hand-held.
16. Always change both blades or covers on the drum, otherwise the resulting imbalance will cause vibration and shorten tool life.
17. Use only Makita blades specified in this manual.
18. Always use the correct dust mask/respirator for the material and application you are working with.

## SAVE THESE INSTRUCTIONS.

### **⚠WARNING:**

DO NOT let comfort or familiarity with product (gained from repeated use) replace strict adherence to safety rules for the subject product. MISUSE or failure to follow the safety rules stated in this instruction manual may cause serious personal injury.

## FUNCTIONAL DESCRIPTION

### **⚠CAUTION:**

- Always be sure that the tool is switched off and unplugged before adjusting or checking function on the tool.

### Adjusting depth of cut

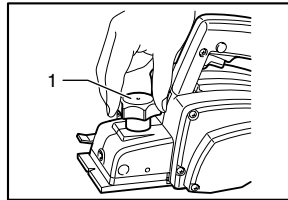

1. Knob

004879

Depth of cut may be adjusted by simply turning the knob on the front of the tool.

### Switch action

### **⚠CAUTION:**

- Before plugging in the tool, always check to see that the switch trigger actuates properly and returns to the "OFF" position when released.

### For tool without lock button and lock-off button

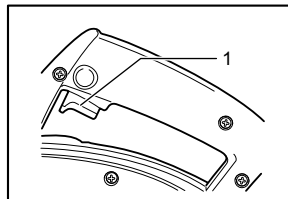

1. Switch trigger

004881

To start the tool, simply pull the switch trigger. Release the switch trigger to stop.

### For tool with lock button

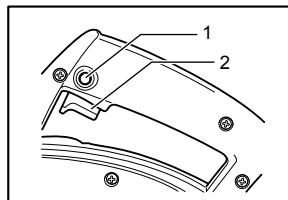

1. Lock button / Lock-off button  
2. Switch trigger

004884

To start the tool, simply pull the switch trigger. Release the switch trigger to stop.

For continuous operation, pull the switch trigger and then push in the lock button.

To stop the tool from the locked position, pull the switch trigger fully, then release it.

**For tool with lock-off button**

To prevent the switch trigger from being accidentally pulled, a lock-off button is provided.

To start the tool, depress the lock-off button and pull the switch trigger. Release the switch trigger to stop.

**ASSEMBLY**

**⚠ CAUTION:**

- Always be sure that the tool is switched off and unplugged before carrying out any work on the tool.

**Removing or installing planer blades**

**⚠ CAUTION:**

- Tighten the blade installation bolts carefully when attaching the blades to the tool. A loose installation bolt can be dangerous. Always check to see they are tightened securely.
- Handle the blades very carefully. Use gloves or rags to protect your fingers or hands when removing or installing the blades.
- Use only the Makita wrench provided to remove or install the blades. Failure to do so may result in overtightening or insufficient tightening of the installation bolts. This could cause an injury.

**For tool with standard planer blades**

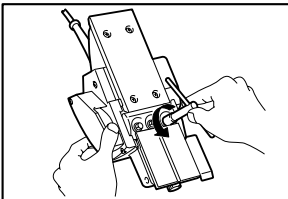

004886

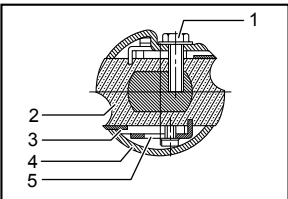

002555

1. Bolt
2. Drum
3. Planer blade
4. Drum cover
5. Adjusting plate

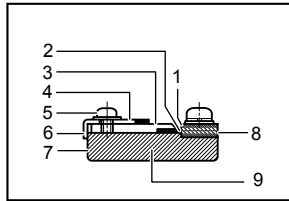

002556

1. Inside edge of gauge plate
2. Blade edge
3. Planer blade
4. Adjusting plate
5. Screws
6. Heel
7. Back side of gauge base
8. Gauge plate
9. Gauge base

To remove the blades on the drum, unscrew the installation bolts with the socket wrench. The drum cover comes off together with the blades.

To install the blades, first clean out all chips or foreign matter adhering to the drum or blades. Use blades of the same dimensions and weight, or drum oscillation/vibration will result, causing poor planing action and, eventually, tool breakdown.

Place the blade on the gauge base so that the blade edge is perfectly flush with the inside edge of the gauge plate. Place the adjusting plate on the blade, then simply press in the heel of the adjusting plate flush with the back side of the gauge base and tighten two screws on the adjusting plate. Now slip the heel of the adjusting plate into the drum groove, then fit the drum cover on it. Tighten all the installation bolts evenly and alternately with the socket wrench.

**For tool with mini planer blades**

1. Remove the existing blade, if the tool has been in use, carefully clean the drum surfaces and the drum cover. To remove the blades on the drum, unscrew the three installation bolts with the socket wrench. The drum cover comes off together with the blades.

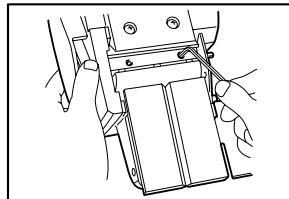

004887

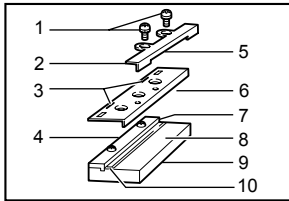

002565

1. Pan head screw
2. Adjusting plate
3. Planer blade locating lugs
4. Gauge plate
5. Heel of adjusting plate
6. Set plate
7. Inside flank of gauge plate
8. Gauge base
9. Back side of gauge base
10. Mini planer blade

8. Tighten the three hex flange head bolts (with the socket wrench provided) and rotate the drum to check clearances between the blade ends and the tool body.
9. Check the three hex flange head bolts for final tightness.
10. Repeat procedures 1 - 9 for other blade.

2. To install the blades, loosely attach the adjusting plate to the set plate with the pan head screws and set the mini planer blade on the gauge base so that the cutting edge of the blade is perfectly flush with the inside flank of the gauge plate.
3. Set the adjusting plate/set plate on the gauge base so that the planer blade locating lugs on the set plate rest in the mini planer blade groove, then press in the heel of the adjusting plate flush with the back side of the gauge base and tighten the pan head screws.
4. It is important that the blade sits flush with the inside flank of the gauge plate, the planer blade locating lugs sit in the blade groove and the heel of the adjusting plate is flush with the back side of the gauge base. Check this alignment carefully to ensure uniform cutting.
5. Slip the heel of the adjusting plate into the groove of the drum.

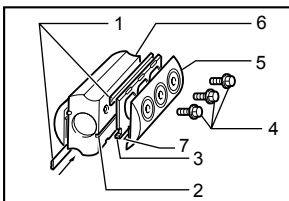

1. Mini planer blade
2. Groove
3. Set plate
4. Hex. flange head bolt
5. Drum plate
6. Drum
7. Adjusting plate

010705

6. Set the drum cover over the adjusting plate/set plate and screw in the three hex flange head bolts so that a gap exists between the drum and the set plate to slide the mini planer blade into position. The blade will be positioned by the planer blade locating lugs on the set plate.
7. The blade's lengthwise adjustment will need to be manually positioned so that the blade ends are clear and equidistant from the housing on one side and the metal bracket on the other.

## For the correct planer blade setting

Your planing surface will end up rough and uneven, unless the blade is set properly and securely. The blade must be mounted so that the cutting edge is absolutely level, that is, parallel to the surface of the rear base.

Refer to some examples below for proper and improper settings.

- (A) Front base (Movable shoe)
- (B) Rear base (Stationary shoe)

### Correct setting

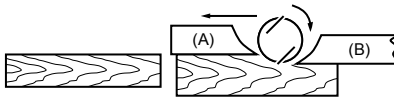

Although this side view cannot show it, the edges of the blades run perfectly parallel to the rear base surface.

### Nicks in surface



Cause: One or both blades fails to have edge parallel to rear base line.

### Gouging at start

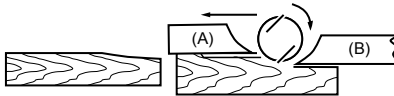

Cause: One or both blade edges fails to protrude enough in relation to rear base line.

### Gouging at end

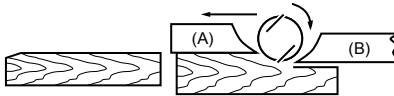

Cause: One or both blade edges protrudes too far in relation to rear base line.

EN0004-1

## Connecting a vacuum cleaner

### For European countries and areas

When you wish to perform clean planing operation, connect a Makita vacuum cleaner to your tool. Install the nozzle on the tool using the screws. Then connect a hose of the vacuum cleaner to the nozzle as shown in the figures.

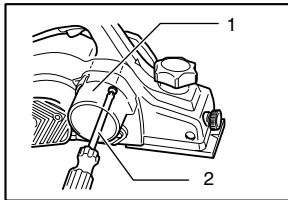

- 1. Chip cover
- 2. Screwdriver

004902

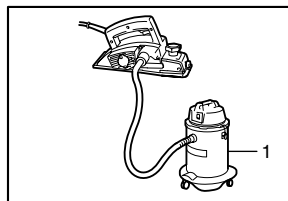

- 1. Vacuum cleaner

004951

## For other countries and areas

A nozzle and joint (optional accessories) are necessary to connect a Makita vacuum cleaner to your tool. Consult a Makita catalogue or representative on the nozzle and joint.

## Nozzle assembly (optional accessory)

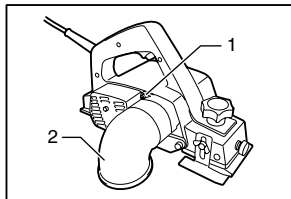

1. Screw
2. Nozzle assembly

004895

Use of the special nozzle assembly will minimize chip scatter, making for a cleaner work area.

The nozzle assembly may be attached after the chip cover on the tool body is removed. When slipping on the assembly, fit the pin on it into the rear cover hole. Use the chip cover screws to fasten it in place.

## OPERATION

### Planing operation

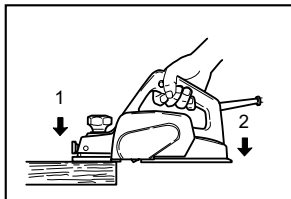

1. Start
2. End

004897

First, rest the tool front base flat upon the workpiece surface without the blades making any contact. Switch on and wait until the blades attain full speed. Then move the tool gently forward. Apply pressure on the front of tool at the start of planing, and at the back at the end of planing. Planing will be easier if you incline the workpiece in stationary fashion, so that you can plane somewhat downhill.

The speed and depth of cut determine the kind of finish. The power planer keeps cutting at a speed that will not result in jamming by chips. For rough cutting, the depth of cut can be increased, while for a good finish you should reduce the depth of cut and advance the tool more slowly.

## Shiplapping (Rabbeting)

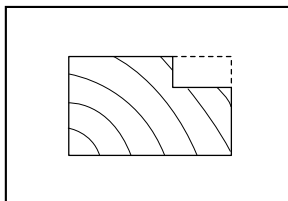

002580

To make a stepped cut as shown in the figure, use the edge fence (guide rule).

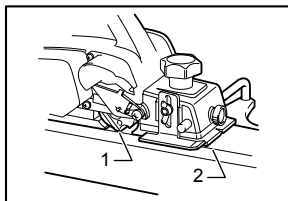

1. Blade edge
2. Cutting line

004898

Draw a cutting line on the workpiece. Insert the edge fence into the hole in the front of the tool. Align the blade edge with the cutting line.

Adjust the edge fence until it comes in contact with the side of the workpiece, then secure it by tightening the screw.

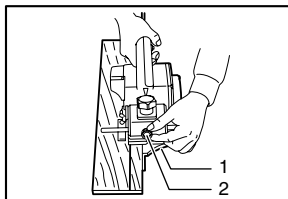

1. Edge fence
2. Screw

004899

When planing, move the tool with the edge fence flush with the side of the workpiece. Otherwise uneven planing may result.

Maximum shiplapping (rabbeting) depth is 23 mm.

You may wish to add to the length of the fence by attaching an extra piece of wood. Convenient holes are provided in the fence for this purpose, and also for attaching an extension guide (optional accessory).



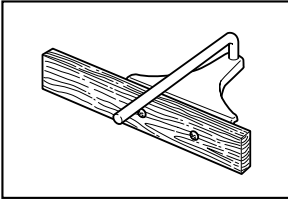

002584

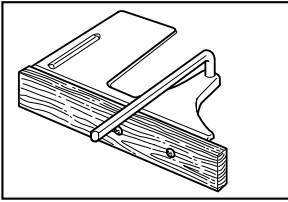

010709

**CAUTION:**

- The blade edge should be made to protrude outside slightly (0.3 mm - 0.6 mm). Otherwise, nicks and generally poor shiplapping results.

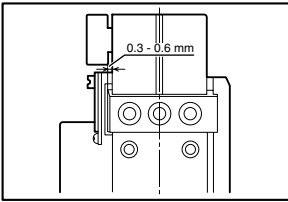

004900

**Chamfering**

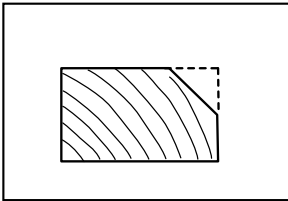

003634

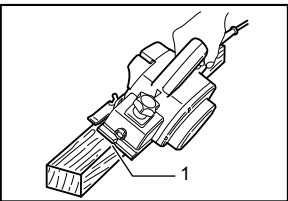

004901

1. V groove

To make a chamfering cut as shown in the figure, align the "V" groove in the front base with the edge of the workpiece and plane it.

**MAINTENANCE**

**CAUTION:**

- Always be sure that the tool is switched off and unplugged before attempting to perform inspection or maintenance.
- Never use gasoline, benzine, thinner, alcohol or the like. Discoloration, deformation or cracks may result.

**Sharpening the planer blades**

**For standard blades only**

Always keep your blades sharp for the best performance possible. Use the sharpening holder to remove nicks and produce a fine edge.

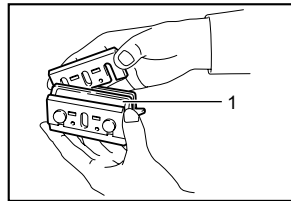

1. Sharpening holder

002588

First, loosen the two wing nuts on the holder and insert the blades (A) and (B), so that they contact the sides (C) and (D). Then tighten the wing nuts.

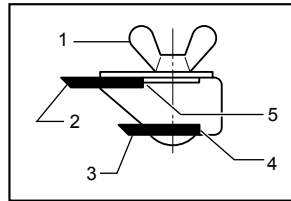

1. Wing nut  
2. Blade (A)  
3. Blade (B)  
4. Side (D)  
5. Side (C)

002589

Immerse the dressing stone in water for 2 or 3 minutes before sharpening. Hold the holder so that the both blades contact the dressing stone for simultaneous sharpening at the same angle.

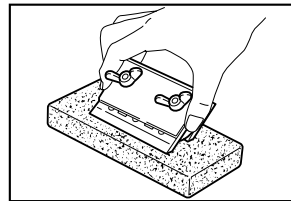

002590

## Replacing carbon brushes

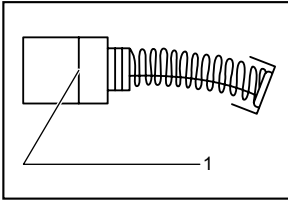

1. Limit mark

001145

Remove and check the carbon brushes regularly. Replace when they wear down to the limit mark. Keep the carbon brushes clean and free to slip in the holders. Both carbon brushes should be replaced at the same time. Use only identical carbon brushes.

Use a screwdriver to remove the rear cover.

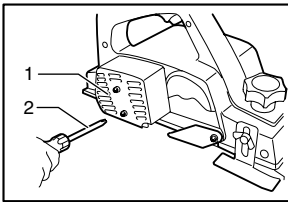

1. Rear cover  
2. Screwdriver

004904

Take out the worn carbon brushes, insert the new ones and secure the rear cover.

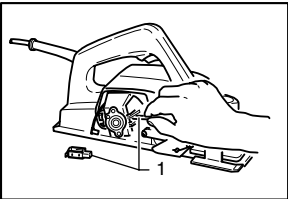

1. Carbon brushes

004906

To maintain product SAFETY and RELIABILITY, repairs, any other maintenance or adjustment should be performed by Makita Authorized Service Centers, always using Makita replacement parts.

## OPTIONAL ACCESSORIES

### ⚠ CAUTION:

- These accessories or attachments are recommended for use with your Makita tool specified in this manual. The use of any other accessories or attachments might present a risk of injury to persons. Only use accessory or attachment for its stated purpose.

If you need any assistance for more details regarding these accessories, ask your local Makita Service Center.

- High-speed steel Planer blade
- Tungsten-carbide Planer blade (For longer blade life)
- Mini planer blade
- Sharpening holder assembly
- Blade gauge
- Set plate set
- Edge fence (Guide rule)
- Extension guide set
- Dressing stone
- Nozzle assembly
- Dust bag assembly
- Joint
- Socket wrench
- Hex wrench

### NOTE:

- Some items in the list may be included in the tool package as standard accessories. They may differ from country to country.



Makita Corporation